

Preisliste Deutschland 2019  
gültig ab 1. Dezember 2018

# Druckrohrsystem Bögen

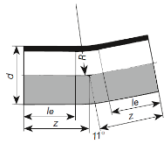



PE100-RC Bogen univ. 11° RC SDR 17  
PE100-RC Bogen univ. 11° RC SDR 11

1

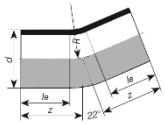

PE100-RC Bogen univ. 22° RC SDR 17  
PE100-RC Bogen univ. 22° RC SDR 11

2

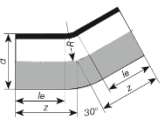

PE100-RC Bogen univ. 30° RC SDR 17  
PE100-RC Bogen univ. 30° RC SDR 11

3

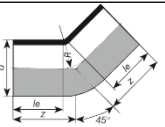

PE100-RC Bogen univ. 45° RC SDR 17  
PE100-RC Bogen univ. 45° RC SDR 11

4

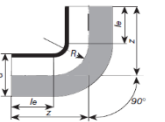

PE100-RC Bogen univ. 90° RC SDR 17  
PE100-RC Bogen univ. 90° RC SDR 11

5

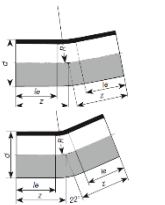

Bogen 11° PE100 SDR17  
Bogen 11° PE100 SDR11

6

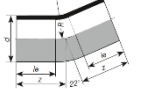

Bogen 22° PE100 SDR17  
Bogen 22° PE100 SDR11

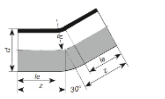

Bogen 30° PE100 SDR17  
Bogen 30° PE100 SDR11

8

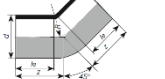

Bogen 45° PE100 SDR17  
Bogen 45° PE100 SDR11

# Bögen

PF 2 51 301 010

## Bogen PE100-RC univ. 11° SDR11

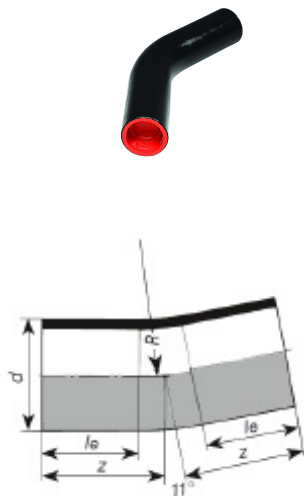

d (mm)	Code	EUR	SP	Gewicht (kg)	GP	l (mm)	z (mm)	R (mm)
90	200 014 203	250,30	0	0,900	0	150	200	135
110	200 014 204	323,95	0	1,300	0	150	200	165
125	200 014 205	360,94	0	2,100	0	150	250	187
140	200 014 206	406,02	0	3,100	0	150	300	210
160	200 014 207	476,46	0	4,700	0	150	300	240
180	200 014 208	799,44	0	6,000	0	150	350	270
200	200 014 209	968,48	0	9,500	0	150	450	300
225	200 014 210	1.154,91	0	14,600	0	150	550	337
250	200 014 211	1.346,73	0	17,900	0	250	550	375
280	200 014 212	1.600,24	0	24,600	0	250	600	560
315	200 014 213	1.939,61	0	31,100	0	300	600	630
355	200 014 214	3.546,55	0	52,600	0	300	800	710

PF 2 51 301 010

## Bogen PE100-RC univ. 11° SDR11



d (mm)	Code	EUR	SP	Gewicht (kg)	GP	l (mm)	z (mm)	R (mm)
90	200 014 223	205,51	0	0,600	0	150	200	135
110	200 014 224	256,73	0	0,900	0	150	200	165
125	200 014 225	290,52	0	1,400	0	150	250	187
140	200 014 226	331,59	0	2,100	0	150	300	210
160	200 014 227	365,79	0	3,200	0	150	300	240
180	200 014 228	585,11	0	4,000	0	150	350	270
200	200 014 229	706,89	0	6,400	0	150	450	300
225	200 014 230	839,69	0	9,900	0	150	550	337
250	200 014 231	1.015,40	0	12,200	0	250	550	375
280	200 014 232	1.122,72	0	16,700	0	250	600	560
315	200 014 233	1.447,34	0	21,100	0	300	600	630
355	200 014 234	2.287,02	0	35,800	0	300	800	710

PF 2 51 301 010

**Bogen PE100-RC univ. 22° SDR11**

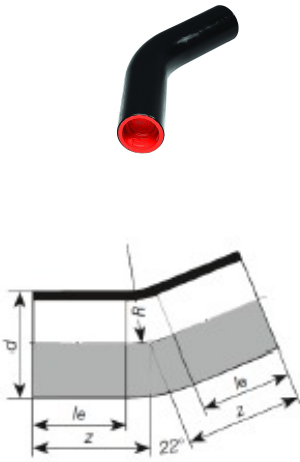

d (mm)	Code	EUR	Gewicht (kg)	l (mm)	z (mm)	R (mm)
90	200 013 703	250,30	0,900	150	200	135
110	200 013 704	323,95	1,300	150	200	165
125	200 013 705	360,94	2,100	150	250	187
140	200 013 706	406,02	3,100	150	300	210
160	200 013 707	476,46	4,700	150	300	240
180	200 013 708	799,44	6,000	150	350	270
200	200 013 709	968,48	9,500	150	450	300
225	200 013 710	1.154,91	14,600	150	550	337
250	200 013 711	1.346,73	17,900	250	550	375
280	200 013 712	1.600,24	24,600	250	600	560
315	200 013 713	1.939,61	31,100	300	600	630
355	200 013 714	3.546,55	52,600	300	800	710

PF 2 51 301 010

**Bogen PE100-RC univ. 22° SDR17**

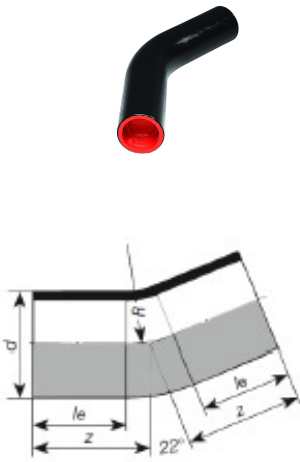

d (mm)	Code	EUR	Gewicht (kg)	l (mm)	z (mm)	R (mm)
90	200 013 723	205,51	0,600	150	200	135
110	200 013 724	256,73	0,900	150	200	165
125	200 013 725	290,52	1,400	150	250	187
140	200 013 726	331,59	2,100	150	300	210
160	200 013 727	365,79	3,200	150	300	240
180	200 013 728	585,11	4,000	150	350	270
200	200 013 729	706,89	6,400	150	450	300
225	200 013 730	839,69	9,900	150	550	337
250	200 013 731	1.015,40	12,200	250	550	375
280	200 013 732	1.122,72	16,700	250	600	560
315	200 013 733	1.447,34	21,100	300	600	630
355	200 013 734	2.287,02	35,800	300	800	710

PF 2 51 301 010

**Bogen PE100-RC univ. 30° SDR11**

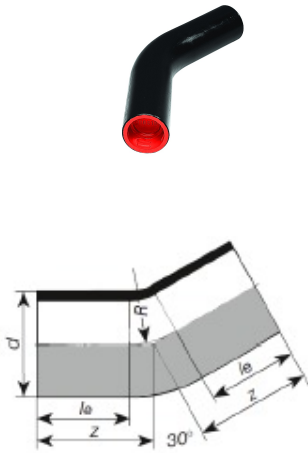

d (mm)	Code	EUR	Gewicht (kg)	l (mm)	z (mm)	R (mm)
90	200 012 703	250,30	0,900	150	200	135
110	200 012 704	323,95	1,300	150	200	165
125	200 012 705	360,94	2,100	150	250	187
140	200 012 706	406,02	3,100	150	300	210
160	200 012 707	476,46	4,700	150	300	240
180	200 012 708	799,44	6,000	150	350	270
200	200 012 709	968,48	9,500	150	450	300
225	200 012 710	1.154,91	14,600	150	550	337
250	200 012 711	1.346,73	17,900	250	550	375
280	200 012 712	1.600,24	24,600	250	600	560
315	200 012 713	1.939,61	31,100	300	600	630
355	200 012 714	3.546,55	52,600	300	800	710

PF 2 51 301 010

**Bogen PE100-RC univ. 30° SDR17**

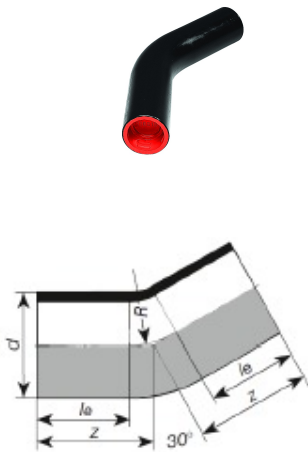

d (mm)	Code	EUR	Gewicht (kg)	l (mm)	z (mm)	R (mm)
90	200 012 723	205,51	0,600	150	200	135
110	200 012 724	256,73	0,900	150	200	165
125	200 012 725	290,52	1,400	150	250	187
140	200 012 726	331,59	2,100	150	300	210
160	200 012 727	365,79	3,200	150	300	240
180	200 012 728	585,11	4,000	150	350	270
200	200 012 729	706,89	6,400	150	450	300
225	200 012 730	839,69	9,900	150	550	337
250	200 012 731	1.015,40	12,200	250	550	375
280	200 012 732	1.122,72	16,700	250	600	560
315	200 012 733	1.447,34	21,100	300	600	630
355	200 012 734	2.287,02	35,800	300	800	710

**Bogen PE100-RC univ. 45° SDR17**

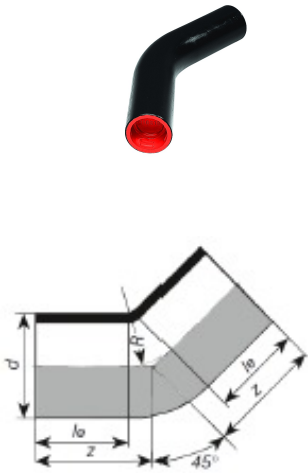

d (mm)	Code	EUR	Gewicht (kg)	l (mm)	z (mm)	R (mm)
90	200 011 723	206,69	0,600	150	250	135
110	200 011 724	259,55	0,900	150	200	165
125	200 011 725	294,97	1,500	150	250	187
140	200 011 726	337,34	2,500	150	350	210
160	200 011 727	374,37	3,200	150	350	240
180	200 011 728	594,89	4,000	150	400	270
200	200 011 729	716,29	6,400	150	450	300
225	200 011 730	853,11	9,900	150	550	337
250	200 011 731	1.047,61	12,200	250	550	375
280	200 011 732	1.166,98	20,900	250	750	560
315	200 011 733	1.507,70	26,400	300	750	630
355	200 011 734	2.287,02	44,800	300	1000	710

**Bogen PE100-RC univ. 45° SDR11**

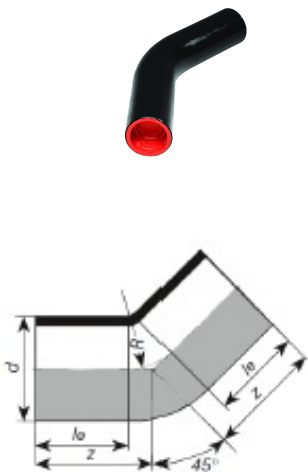

d (mm)	Code	EUR	Gewicht (kg)	l (mm)	z (mm)	R (mm)
90	200 011 703	252,57	1,100	150	250	135
110	200 011 704	327,96	1,600	150	200	165
125	200 011 705	367,40	2,300	150	250	187
140	200 011 706	415,55	3,600	150	350	210
160	200 011 707	489,32	4,700	150	350	240
180	200 011 708	812,87	6,800	150	400	270
200	200 011 709	983,22	9,500	150	450	300
225	200 011 710	1.173,69	14,600	150	550	337
250	200 011 711	1.393,68	17,900	250	550	375
280	200 011 712	1.665,97	30,800	250	750	560
315	200 011 713	2.030,83	38,900	300	750	630
355	200 011 714	3.546,55	65,800	300	1000	710

PF 2 51 301 010

**Bogen PE100-RC univ. 90° SDR17**

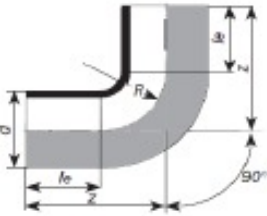

d (mm)	Code	EUR	Gewicht (kg)	l (mm)	z (mm)	R (mm)
90	200 010 723	91,08	0,900	150	300	135
110	200 010 724	114,03	1,300	150	300	165
125	200 010 725	131,86	2,200	150	400	187
140	200 010 726	152,25	3,200	150	450	210
160	200 010 727	171,82	4,100	150	450	240
180	200 010 728	274,43	5,200	150	450	270
200	200 010 729	329,85	7,800	150	550	300
225	200 010 730	388,98	12,500	150	690	337
250	200 010 731	645,32	15,000	250	675	375
280	200 010 732	839,69	13,400	250	570	420
315	200 010 733	1.160,27	18,500	300	625	475
355	200 010 734	2.214,59	28,000	300	685	535

PF 2 51 301 010

**Bogen PE100-RC univ. 90° SDR11**

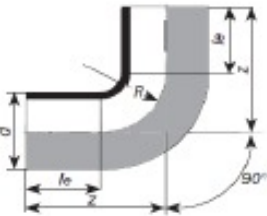

d (mm)	Code	EUR	Gewicht (kg)	l (mm)	z (mm)	R (mm)
90	200 010 703	69,89	1,300	150	300	135
110	200 010 704	110,53	1,900	150	300	165
125	200 010 705	163,64	3,300	150	400	187
140	200 010 706	251,23	4,600	150	450	210
160	200 010 707	263,17	6,100	150	450	240
180	200 010 708	331,18	7,700	150	450	270
200	200 010 709	348,47	11,600	150	550	300
225	200 010 710	461,98	18,400	150	690	337
250	200 010 711	717,63	22,000	250	675	375
280	200 010 712	933,59	20,500	250	570	420
315	200 010 713	1.290,40	26,700	300	625	475
355	200 010 714	3.331,92	44,900	300	685	535

PF 2 51 301 010

**Bogen PE100 11° SDR17**



d (mm)	Code	EUR	Gewicht (kg)	l (mm)	z (mm)	R (mm)
400	<b>200 014 235</b>	<b>3.170,98</b>	61,800	300	1200	1400
450	<b>200 014 236</b>	<b>3.805,44</b>	81,500	300	1200	1575
500	<b>200 014 237</b>	<b>5.213,87</b>	104,600	350	1200	2000

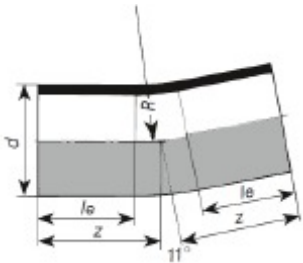

PF 2 51 301 010

**Bogen PE100 11° SDR11**



d (mm)	Code	EUR	Gewicht (kg)	l (mm)	z (mm)	R (mm)
400	<b>200 014 215</b>	<b>3.784,94</b>	95,100	300	1200	1400
450	<b>200 014 216</b>	<b>4.779,26</b>	125,700	300	1200	1575
500	<b>200 014 217</b>	<b>6.696,07</b>	161,500	350	1200	2000

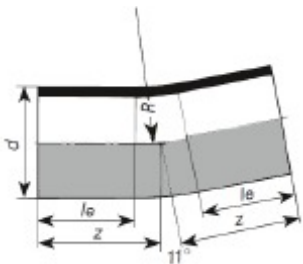

PF 2 51 301 010

**Bogen PE100 22° SDR17**



d (mm)	Code	EUR	Gewicht (kg)	l (mm)	z (mm)	R (mm)
400	<b>200 013 735</b>	<b>3.170,98</b>	61,800	300	1200	1400
450	<b>200 013 736</b>	<b>3.805,44</b>	81,500	300	1200	1575
500	<b>200 013 737</b>	<b>5.213,87</b>	104,600	350	1200	2000

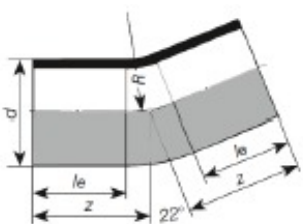



PF 2 51 301 010

**Bogen PE100 22° SDR11**



d (mm)	Code	EUR	Gewicht (kg)	l (mm)	z (mm)	R (mm)
400	<b>200 013 715</b>	<b>3.899,33</b>	95,100	300	1200	1400
450	<b>200 013 716</b>	<b>4.779,26</b>	125,700	300	1200	1575
500	<b>200 013 717</b>	<b>6.696,07</b>	161,500	350	1200	2000

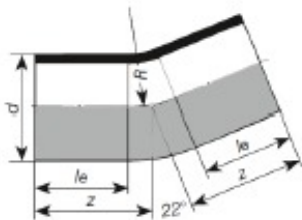

PF 2 51 301 010

**Bogen PE100 30° SDR17**



d (mm)	Code	EUR	Gewicht (kg)	l (mm)	z (mm)	R (mm)
400	<b>200 012 735</b>	<b>3.170,98</b>	61,800	300	1500	1400
450	<b>200 012 736</b>	<b>3.805,44</b>	81,500	300	1500	1575
500	<b>200 012 737</b>	<b>5.213,87</b>	104,600	350	1500	2000

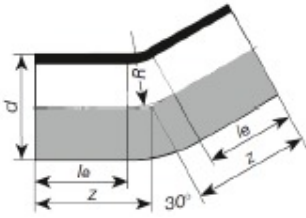

PF 2 51 301 010

**Bogen PE100 30° SDR11**



d (mm)	Code	EUR	Gewicht (kg)	l (mm)	z (mm)	R (mm)
400	<b>200 012 715</b>	<b>3.899,33</b>	95,100	300	1500	1400
450	<b>200 012 716</b>	<b>4.779,26</b>	125,700	300	1500	1575
500	<b>200 012 717</b>	<b>6.696,07</b>	161,500	350	1500	2000

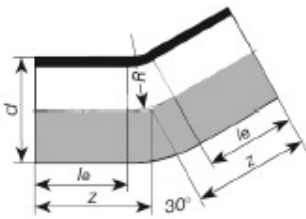

PF 2 51 301 010

**Bogen PE100 45° SDR17**



d (mm)	Code	EUR	Gewicht (kg)	l (mm)	z (mm)	R (mm)
400	<b>200 011 735</b>	<b>3.170,98</b>	61,800	300	1800	1400
450	<b>200 011 736</b>	<b>3.808,12</b>	84,800	300	1800	1575
500	<b>200 011 737</b>	<b>5.215,20</b>	113,000	350	1800	2000

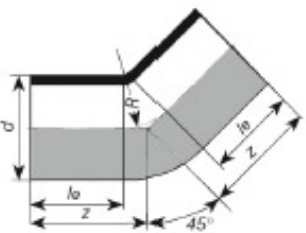

PF 2 51 301 010

### Bogen PE100 45° SDR11



d (mm)	Code	EUR	Gewicht (kg)	l (mm)	z (mm)	R (mm)
400	200 011 715	3.899,33	95,100	300	1800	1400
450	200 011 716	4.780,60	131,000	300	1800	1575
500	200 011 717	6.700,09	174,000	350	1800	2000

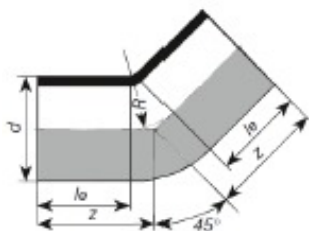

# Ihr Kontakt

Unsere Verkaufsgesellschaften und Vertriebspartner vor Ort bieten Ihnen Beratung, Service und Seminare an.

## Verkaufsgesellschaft Deutschland

Georg Fischer GmbH  
Daimlerstraße 6  
73095 Albershausen  
Telefon +49 7161 302-0  
Fax +49 7161 302-259  
info.de.ps@georgfischer.com  
[www.gfps.com/de](http://www.gfps.com/de)

## Verkaufsbüro Hannover

Georg Fischer GmbH  
Heidering 37-39  
30625 Hannover  
Telefon +49 511 957 88-0  
Fax +49 511 957 88-44

## Verkaufsbüro Leipzig

Georg Fischer GmbH  
Georg-Fischer-Straße 2  
04249 Leipzig  
Telefon +49 341 484 70-0  
Fax +49 341 484 70-21

## Verkaufsbüro Neuburg

Georg Fischer GmbH  
Nördliche Grünauer Straße 65  
86633 Neuburg  
Telefon +49 8431 58 17-0  
Fax +49 8431 58 17-20

Die technischen Daten sind unverbindlich. Sie gelten nicht als zugesicherte Eigenschaften oder als Beschaffenheits- oder Haltbarkeitsgarantien. Änderungen vorbehalten. Es gelten unsere Allgemeinen Verkaufsbedingungen.